

Inspiron 20 Owner's Manual

Computer Model: Inspiron 20 Model 3045
Regulatory Model: W09B
Regulatory Type: W09B002



Notes, Cautions, and Warnings



NOTE: A NOTE indicates important information that helps you make better use of your computer.



CAUTION: A CAUTION indicates either potential damage to hardware or loss of data and tells you how to avoid the problem.



WARNING: A WARNING indicates a potential for property damage, personal injury, or death.

Copyright © 2014 Dell Inc. All rights reserved. This product is protected by U.S. and international copyright and intellectual property laws. Dell™ and the Dell logo are trademarks of Dell Inc. in the United States and/or other jurisdictions. All other marks and names mentioned herein may be trademarks of their respective companies.

2014 - 03

Rev. A00

Contents

Before Working Inside Your Computer	9
Before You Begin	9
Safety Instructions.....	9
Recommended Tools.....	10
After Working Inside Your Computer	12
Technical Overview	13
Inside View of Your Computer.....	13
System Board Components	14
Removing the Stand Assembly	15
Procedure.....	15
Replacing the Stand Assembly	18
Procedure.....	18
Removing the Back Cover	19
Prerequisites.....	19
Procedure	19
Replacing the Back Cover	20
Procedure.....	20
Postrequisites	20
Removing the VESA-Mount Bracket	21
Prerequisites.....	21
Procedure.....	21

Replacing the VESA-Mount Bracket.....	22
Procedure.....	22
Postrequisites.....	22
Removing the Hard Drive.....	23
Prerequisites.....	23
Procedure.....	24
Replacing the Hard Drive.....	26
Procedure.....	26
Postrequisites	26
Removing the Optical Drive.....	27
Prerequisites.....	27
Procedure.....	27
Replacing the Optical Drive.....	29
Procedure.....	29
Postrequisites	29
Removing the Memory Module(s).....	30
Prerequisites.....	30
Procedure.....	30
Replacing the Memory Module(s).....	32
Procedure.....	32
Postrequisites.....	32
Removing the Control-Buttons Board.....	33
Prerequisites.....	33
Procedure.....	33

Replacing the Control-Buttons Board.....	35
Procedure.....	35
Postrequisites.....	35
Removing the Converter Board.....	36
Prerequisites.....	36
Procedure.....	36
Replacing the Converter Board.....	38
Procedure.....	38
Postrequisites.....	38
Removing the System-Board Shield.....	39
Prerequisites.....	39
Procedure.....	39
Replacing the System-Board Shield.....	40
Procedure.....	40
Postrequisites	40
Removing the Wireless Card.....	41
Prerequisites.....	41
Procedure.....	41
Replacing the Wireless Card.....	43
Procedure.....	43
Postrequisites.....	43
Removing the Coin-Cell Battery.....	44
Prerequisites.....	44
Procedure.....	44

Replacing the Coin-Cell Battery.....	46
Procedure.....	46
Postrequisites.....	46
Removing the Heat Sink.....	47
Prerequisites.....	47
Procedure.....	47
Replacing the Heat Sink.....	49
Procedure.....	49
Postrequisites.....	49
Removing the Speaker Cover.....	50
Prerequisites.....	50
Procedure.....	50
Replacing the Speaker Cover.....	51
Procedure.....	51
Postrequisites.....	51
Removing the Speakers.....	52
Prerequisites.....	52
Procedure	52
Replacing the Speakers.....	54
Procedure	54
Postrequisites.....	54
Removing the Antenna(s).....	55
Prerequisites.....	55
Procedure.....	55

Replacing the Antenna(s)	57
Procedure.....	57
Postrequisites.....	57
Removing the Fan	58
Prerequisites.....	58
Procedure.....	58
Replacing the Fan	60
Procedure.....	60
Postrequisites.....	60
Removing the System Board	61
Prerequisites.....	61
Procedure	62
Replacing the System Board	64
Procedure.....	64
Postrequisites.....	64
Removing the Camera	65
Prerequisites.....	65
Procedure.....	65
Replacing the Camera	69
Procedure.....	69
Postrequisites.....	69
Removing the Display Panel	70
Prerequisites.....	70
Procedure.....	70

Replacing the Display Panel	76
Procedure.....	76
Postrequisites.....	76
Flashing the BIOS	78
Getting Help and Contacting Dell	79
Self-Help Resources.....	79
Contacting Dell.....	79

Before Working Inside Your Computer

 **CAUTION:** To avoid damaging the components and cards, handle them by their edges and avoid touching pins and contacts.

Before You Begin

- 1 Save and close all open files and exit all open applications.
- 2 Shut down your computer.
 - Windows 8: Move your mouse pointer to the upper-right or lower-right corner of the screen to open the charms sidebar, and then click or tap **Settings** → **Power** → **Shut down**.
 - Windows 7: Click or tap **Start**  → **Shut down** .



NOTE: If you are using a different operating system, see the documentation of your operating system for shut-down instructions.

- 3 Disconnect your computer and all attached devices from their electrical outlets.
- 4 Disconnect all cables such as telephone cables, network cables and so on, from your computer.
- 5 Disconnect all attached devices and peripherals, such as keyboard, mouse, monitor, and so on, from your computer.
- 6 Remove any media card and optical disc from your computer, if applicable.
- 7 After the computer is unplugged, press and hold the power button for 5 seconds to ground the system board.











CAUTION: Place the computer on a flat, soft and clean surface to avoid scratching the display.

- 8 Place the computer face down.

Safety Instructions

Use the following safety guidelines to protect your computer from potential damage and ensure your personal safety.

-  **WARNING:** Before working inside your computer, read the safety information that shipped with your computer. For more safety best practices, see the Regulatory Compliance home page at dell.com/regulatory_compliance.
-  **WARNING:** Disconnect all power sources before opening the computer cover or panels. After you finish working inside the computer, replace all covers, panels, and screws before connecting to the power source.
-  **CAUTION:** To avoid damaging the computer, make sure that the work surface is flat and clean.
-  **CAUTION:** To avoid damaging the components and cards, handle them by their edges and avoid touching pins and contacts.
-  **CAUTION:** Only a certified service technician is authorized to remove the computer cover and access any of the components inside the computer. See the safety instructions for complete information about safety precautions, working inside your computer, and protecting against electrostatic discharge.
-  **CAUTION:** Before touching anything inside your computer, ground yourself by touching an unpainted metal surface, such as the metal at the back of the computer. While you work, periodically touch an unpainted metal surface to dissipate static electricity, which could harm internal components.
-  **CAUTION:** When you disconnect a cable, pull on its connector or on its pull-tab, not on the cable itself. Some cables have connectors with locking tabs or thumb-screws that you must disengage before disconnecting the cable. When disconnecting cables, keep them evenly aligned to avoid bending any connector pins. When connecting cables, make sure that the ports and connectors are correctly oriented and aligned.
-  **CAUTION:** To disconnect a network cable, first unplug the cable from your computer and then unplug the cable from the network device.
-  **CAUTION:** Press and eject any installed card from the media-card reader.

Recommended Tools

The procedures in this document may require the following tools:

- Philips screwdriver
- Flat-head screwdriver
- Plastic scribe

After Working Inside Your Computer



CAUTION: Leaving stray or loose screws inside your computer may severely damage your computer.

- 1 Replace all screws and make sure that no stray screws remain inside your computer.
- 2 Connect any external devices, peripherals, and cables you removed before working on your computer.
- 3 Replace any media cards, discs, and any other part(s) that you removed before working on your computer.
- 4 Connect your computer and all attached devices to their electrical outlets.
- 5 Turn on your computer.

Technical Overview



WARNING: Before working inside your computer, read the safety information that shipped with your computer and follow the steps in [Before Working Inside Your Computer](#). After working inside your computer, follow the instructions in [After Working Inside Your Computer](#). For more safety best practices, see the Regulatory Compliance home page at dell.com/regulatory_compliance.

Inside View of Your Computer

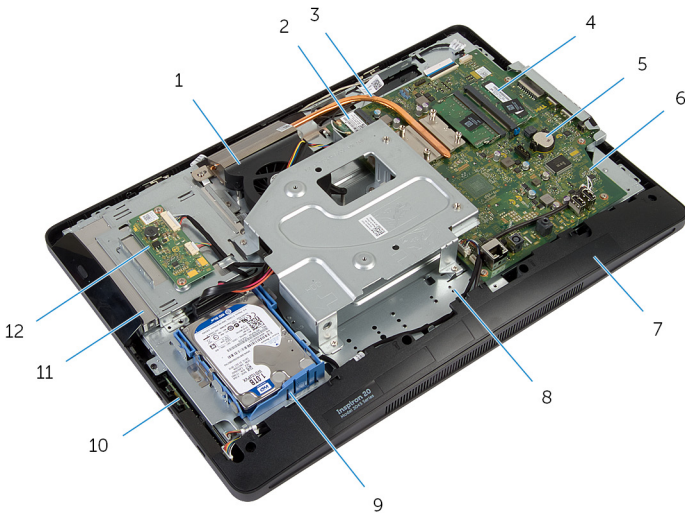

- | | | | |
|----|------------------------|----|-----------------------|
| 1 | fan | 2 | wireless card |
| 3 | heat-sink | 4 | memory module(s) |
| 5 | coin-cell battery | 6 | system board |
| 7 | speaker cover | 8 | display-panel base |
| 9 | hard-drive assembly | 10 | control-buttons board |
| 11 | optical-drive assembly | 12 | converter board |

System Board Components

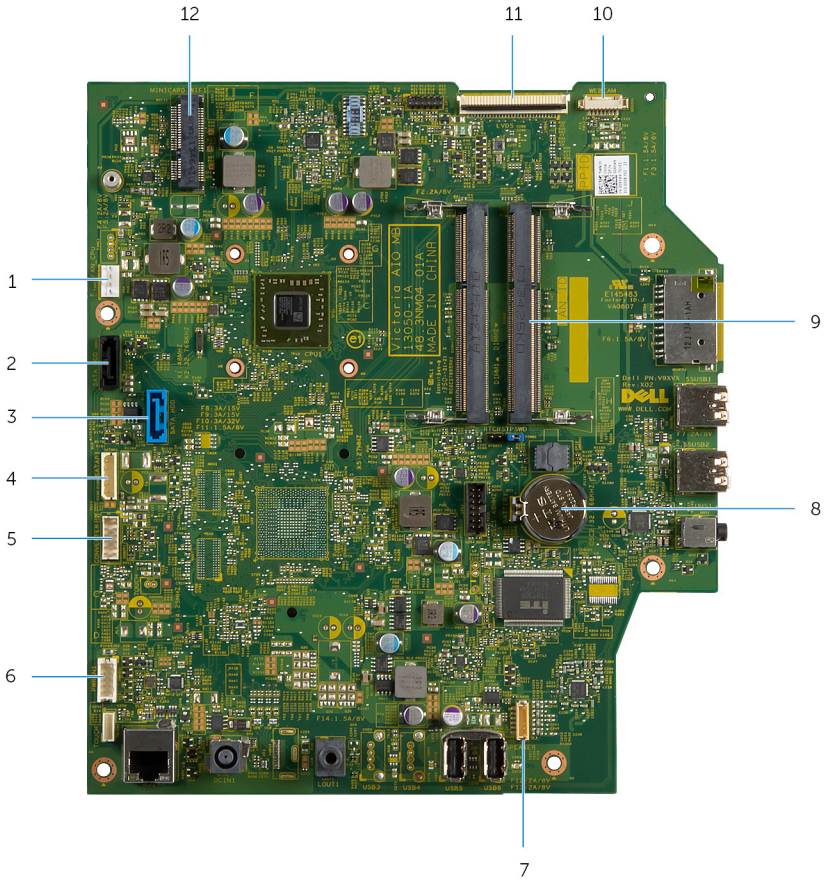

- | | | | |
|----|---------------------------------|----|--|
| 1 | fan-cable connector | 2 | optical-drive cable connector |
| 3 | hard-drive cable connector | 4 | hard-drive and optical-drive power cable connector |
| 5 | converter-board cable connector | 6 | control-buttons cable connector |
| 7 | speaker-cable connector | 8 | coin-cell battery |
| 9 | memory-module connectors (2) | 10 | camera-cable connector |
| 11 | display-cable connector | 12 | wireless-card connector |

Removing the Stand Assembly

⚠ WARNING: Before working inside your computer, read the safety information that shipped with your computer and follow the steps in [Before Working Inside Your Computer](#). After working inside your computer, follow the instructions in [After Working Inside Your Computer](#). For more safety best practices, see the Regulatory Compliance home page at dell.com/regulatory_compliance.

Procedure

- 1 Place the computer face down on a soft cloth or a clean surface.
- 2 Release the tabs on the stand cover.
- 3 Slide and remove the stand cover away from the computer.



1 stand cover

2 back cover

- 4 Remove the screws that secure the stand to the display-panel base.

- 5** Pivot the stand upward and slide it away from the computer.

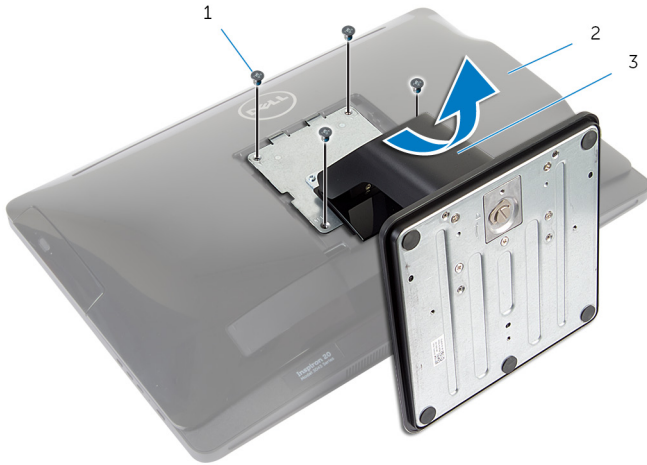

- 1 screws (4)
3 stand

- 2 back cover

If you need to remove either the stand base or stand riser from the stand assembly, follow the steps below:

- 6** Lift the screw handle on the stand base.
7 Using the screw handle, loosen the captive thumbscrew that secures the stand base to the stand riser.

8 Slide the stand base off the stand riser.

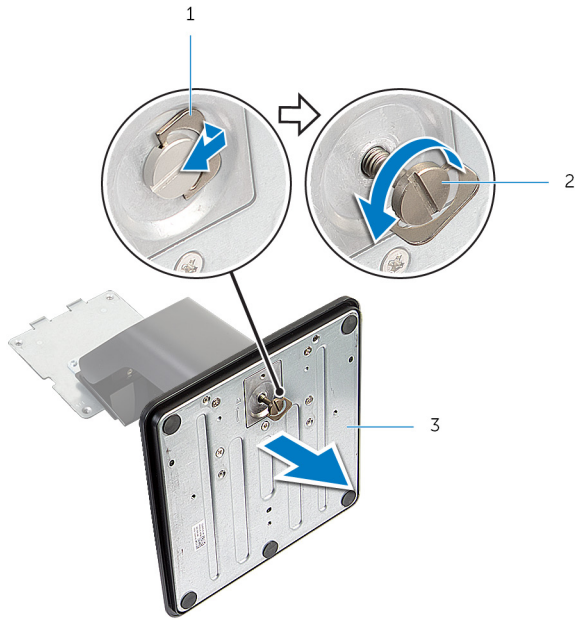

1 screw handle

3 stand base

2 captive thumbscrew

Replacing the Stand Assembly



WARNING: Before working inside your computer, read the safety information that shipped with your computer and follow the steps in [Before Working Inside Your Computer](#). After working inside your computer, follow the instructions in [After Working Inside Your Computer](#). For more safety best practices, see the Regulatory Compliance home page at dell.com/regulatory_compliance.

Procedure

- 1 Slide the tabs on the stand into the slots on the back cover.
- 2 Replace the screws that secure the stand to the display-panel base.
- 3 Slide the tabs on the stand cover into the slots on the back cover and snap the stand cover until it clicks into place.

If you have removed the stand base or the stand riser, follow the steps below:

- 4 Slide the stand base into the slot on the stand riser.
- 5 Tighten the captive thumbscrew and fold the screw handle on the stand base.

Removing the Back Cover

⚠ WARNING: Before working inside your computer, read the safety information that shipped with your computer and follow the steps in [Before Working Inside Your Computer](#). After working inside your computer, follow the instructions in [After Working Inside Your Computer](#). For more safety best practices, see the Regulatory Compliance home page at dell.com/regulatory_compliance.

Prerequisites

Remove the [stand assembly](#).

Procedure

- 1 Using a plastic scribe, pry the back cover from the display bezel starting from around the optical-drive area.
- 2 Lift the back cover off the computer.

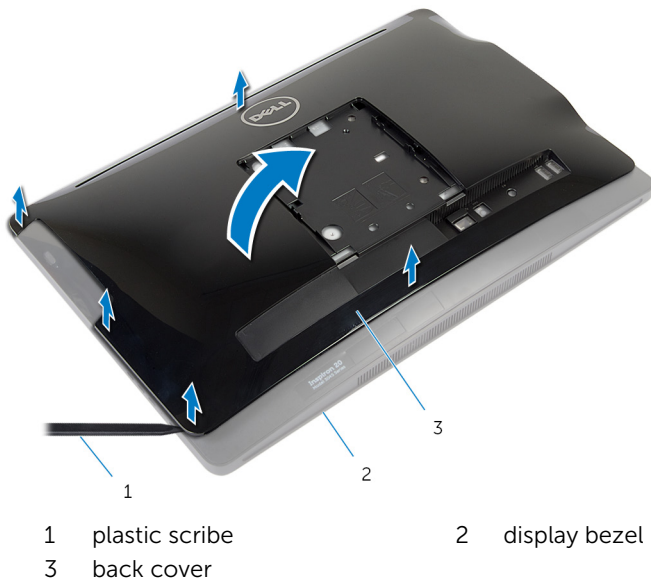

- 1 plastic scribe
- 3 back cover

- 2 display bezel

Replacing the Back Cover



WARNING: Before working inside your computer, read the safety information that shipped with your computer and follow the steps in [Before Working Inside Your Computer](#). After working inside your computer, follow the instructions in [After Working Inside Your Computer](#). For more safety best practices, see the Regulatory Compliance home page at dell.com/regulatory_compliance.

Procedure

- 1 Slide the slots on the back cover into the ports on the computer and align the tabs on the back cover with the slots on the display bezel.
- 2 Snap the back cover into place.

Postrequisites

Replace the [stand assembly](#).

Removing the VESA-Mount Bracket

⚠ WARNING: Before working inside your computer, read the safety information that shipped with your computer and follow the steps in [Before Working Inside Your Computer](#). After working inside your computer, follow the instructions in [After Working Inside Your Computer](#). For more safety best practices, see the Regulatory Compliance home page at dell.com/regulatory_compliance.

Prerequisites

- 1 Remove the [stand assembly](#).
- 2 Remove the [back cover](#).

Procedure

- 1 Remove the screws that secure the VESA-mount bracket to the display-panel base.
- 2 Lift the VESA-mount bracket off the display-panel base.

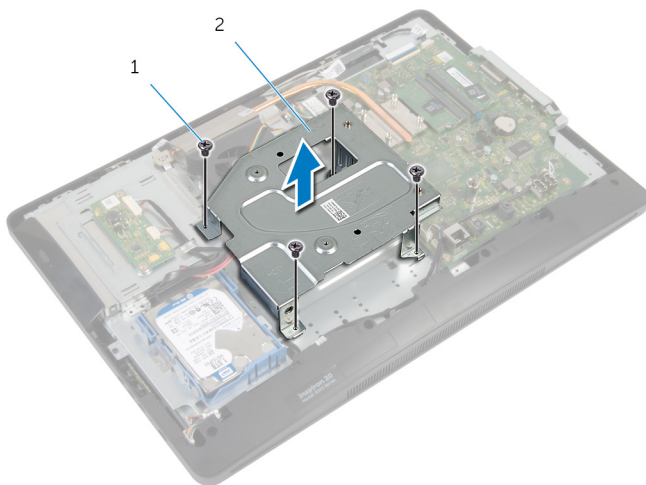

1 screws (4)

2 VESA-mount bracket

Replacing the VESA-Mount Bracket



WARNING: Before working inside your computer, read the safety information that shipped with your computer and follow the steps in [Before Working Inside Your Computer](#). After working inside your computer, follow the instructions in [After Working Inside Your Computer](#). For more safety best practices, see the Regulatory Compliance home page at dell.com/regulatory_compliance.



Procedure

- 1 Align the screw holes on the VESA-mount bracket with the screw holes on the display-panel base.
- 2 Replace the screws that secure the VESA-mount bracket to the display-panel base.

Postrequisites

- 1 Replace the [back cover](#).
- 2 Replace the [stand assembly](#).

Removing the Hard Drive

-  **WARNING:** Before working inside your computer, read the safety information that shipped with your computer and follow the steps in [Before Working Inside Your Computer](#). After working inside your computer, follow the instructions in [After Working Inside Your Computer](#). For more safety best practices, see the Regulatory Compliance home page at dell.com/regulatory_compliance.
-  **CAUTION:** Hard drives are fragile. Exercise care when handling the hard drive.
-  **CAUTION:** To avoid data loss, do not remove the hard drive while the computer is in Sleep or On state.

Prerequisites

- 1 Remove the [stand assembly](#).
- 2 Remove the [back cover](#).

Procedure

- 1 Lift and release the tabs on the hard-drive assembly from the slots on the display-panel base.
- 2 Disconnect the hard-drive and optical-drive power cable from the hard-drive assembly.

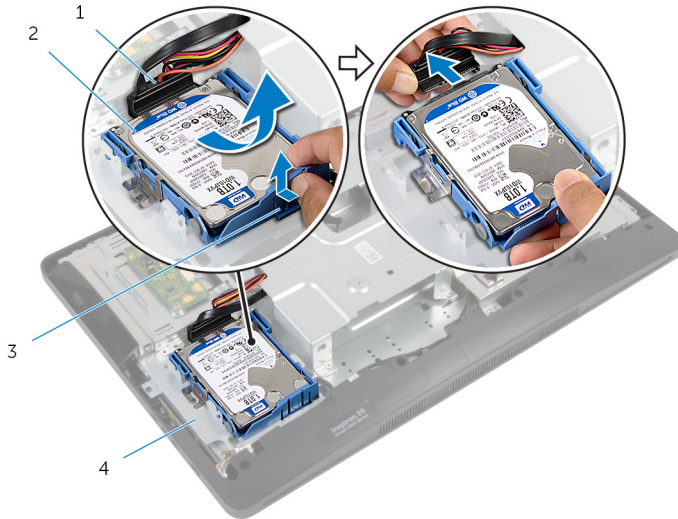

- | | | | |
|---|--|---|---------------------|
| 1 | hard-drive and optical-drive power cable | 2 | hard-drive assembly |
| 3 | tabs | 4 | display-panel base |

- 3 Pull the sides of the hard-drive bracket to release the pins securing the hard drive.

4 Lift the hard drive off the hard-drive bracket.

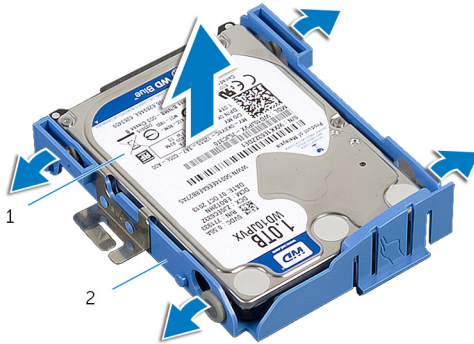

1 hard drive

2 hard-drive bracket

Replacing the Hard Drive

 **WARNING:** Before working inside your computer, read the safety information that shipped with your computer and follow the steps in [Before Working Inside Your Computer](#). After working inside your computer, follow the instructions in [After Working Inside Your Computer](#). For more safety best practices, see the Regulatory Compliance home page at dell.com/regulatory_compliance.

 **CAUTION:** Hard drives are fragile. Exercise care when handling the hard drive.

Procedure

- 1 Pull the sides on the hard-drive bracket and slide the pins on the hard-drive brackets into the holes on the hard drive.
- 2 Connect the hard-drive and optical-drive power cable to the hard-drive assembly.
- 3 Slide the tabs on the hard-drive assembly into the slots on the display-panel base and place the hard-drive assembly on the display-panel base.

 **NOTE:** Make sure that the tabs on the hard-drive bracket are secured on the tabs on the display-panel base.

Postrequisites

- 1 Replace the [back cover](#).
- 2 Replace the [stand assembly](#).

Removing the Optical Drive

⚠ WARNING: Before working inside your computer, read the safety information that shipped with your computer and follow the steps in [Before Working Inside Your Computer](#). After working inside your computer, follow the instructions in [After Working Inside Your Computer](#). For more safety best practices, see the Regulatory Compliance home page at dell.com/regulatory_compliance.

Prerequisites

- 1 Remove the [stand assembly](#).
- 2 Remove the [back cover](#).

Procedure

- 1 Remove the screw that secures the optical-drive assembly to the display-panel base.
- 2 Push the optical-drive bracket to disconnect the optical-drive assembly and then slide the optical-drive assembly out of the optical-drive bay.

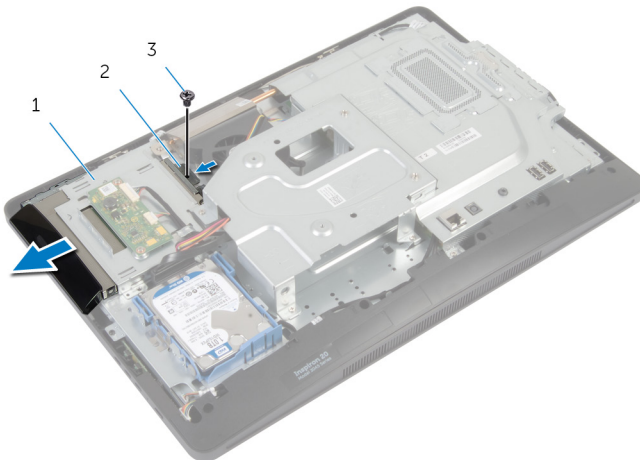

- | | | | |
|---|------------------------|---|-----------------------|
| 1 | optical-drive assembly | 2 | optical-drive bracket |
| 3 | screw | | |

- 3 Carefully pry the optical-drive bezel and remove it from the optical-drive assembly.
- 4 Remove the screws that secure the optical-drive bracket to the optical drive and remove the optical-drive bracket from the optical drive.

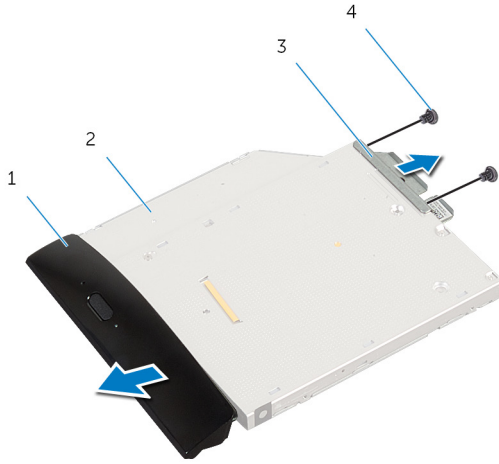

- | | | | |
|---|-----------------------|---|---------------|
| 1 | optical-drive bezel | 2 | optical drive |
| 3 | optical-drive bracket | 4 | screws (2) |

Replacing the Optical Drive



WARNING: Before working inside your computer, read the safety information that shipped with your computer and follow the steps in [Before Working Inside Your Computer](#). After working inside your computer, follow the instructions in [After Working Inside Your Computer](#). For more safety best practices, see the Regulatory Compliance home page at dell.com/regulatory_compliance.

Procedure

- 1 Align the screw holes on the optical-drive bracket with the screw holes on the optical drive.
- 2 Replace the screws that secure the optical-drive bracket to the optical drive.
- 3 Align the tabs on the optical-drive bezel with the slots on the optical-drive assembly and snap the optical-drive bezel into place.
- 4 Slide the optical-drive assembly into the optical-drive bay until it is fully seated.
- 5 Replace the screw that secures the optical-drive assembly to the display-panel base.

Postrequisites

- 1 Replace the [back cover](#).
- 2 Replace the [stand assembly](#).

Removing the Memory Module(s)

 **WARNING:** Before working inside your computer, read the safety information that shipped with your computer and follow the steps in [Before Working Inside Your Computer](#). After working inside your computer, follow the instructions in [After Working Inside Your Computer](#). For more safety best practices, see the Regulatory Compliance home page at dell.com/regulatory_compliance.

Prerequisites

- 1 Remove the [stand assembly](#).
- 2 Remove the [back cover](#).

Procedure

- 1 Using the pull tab, slide the memory-module shield and remove it from the system-board shield.

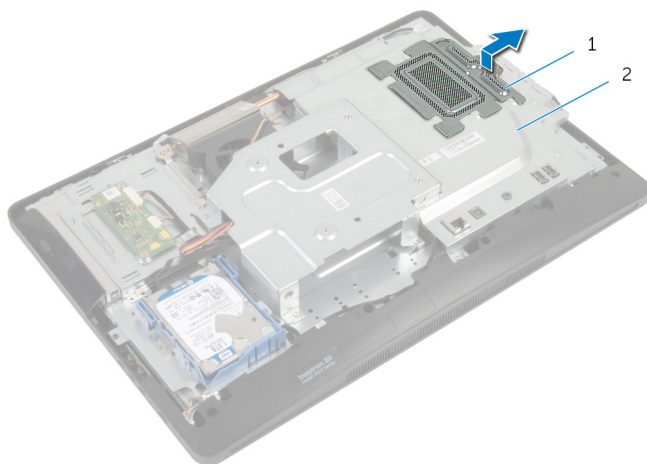

1 memory-module shield 2 system-board shield

- 2 Use your fingertips to spread apart the securing clips on each end of the memory module connector until the memory module pops up.

3 Remove the memory module from the memory-module connector.

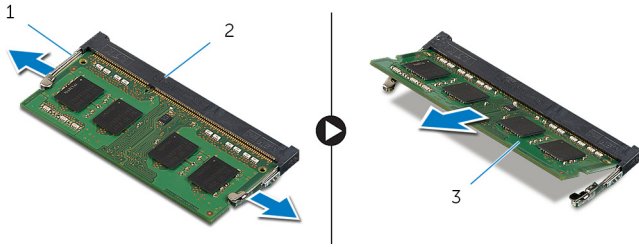

1 securing clips (2)

3 memory module

2 memory-module connector

Replacing the Memory Module(s)

⚠ WARNING: Before working inside your computer, read the safety information that shipped with your computer and follow the steps in [Before Working Inside Your Computer](#). After working inside your computer, follow the instructions in [After Working Inside Your Computer](#). For more safety best practices, see the Regulatory Compliance home page at dell.com/regulatory_compliance.

Procedure

- 1 Align the notch on the memory module with the tab on the memory-module connector.
- 2 Insert the memory module into the memory-module connector, and press the memory module down until it clicks into place.

🔩 NOTE: If you do not hear the click, remove the memory module and reinstall it.

🔩 NOTE: Use the memory module socket marked as DIMM2 if only one memory module is in use.

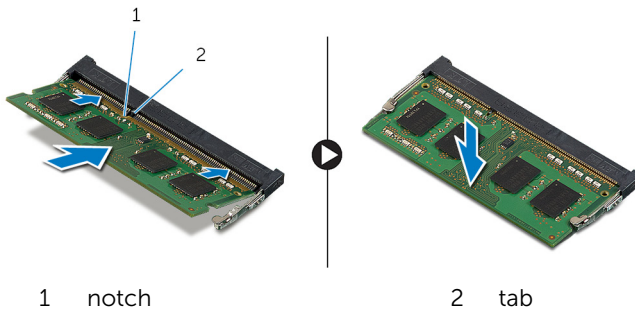

- 3 Slide the tabs on the memory-module shield under the tabs on the system-board shield until the memory-module shield is fully secured.

Postrequisites

- 1 Replace the [back cover](#).
- 2 Replace the [stand assembly](#).

Removing the Control-Buttons Board

 **WARNING:** Before working inside your computer, read the safety information that shipped with your computer and follow the steps in [Before Working Inside Your Computer](#). After working inside your computer, follow the instructions in [After Working Inside Your Computer](#). For more safety best practices, see the Regulatory Compliance home page at dell.com/regulatory_compliance.

Prerequisites

- 1 Remove the [stand assembly](#).
- 2 Remove the [back cover](#).

Procedure

- 1 Using a plastic scribe, pry to release the control-buttons board from the slots on the display bezel.
- 2 Disconnect the control-buttons board cable from the control-buttons board.

3 Lift the control-buttons board away from the display bezel.



- 1 control-buttons board
- 2 plastic scribe
- 3 control-buttons board cable

Replacing the Control-Buttons Board



WARNING: Before working inside your computer, read the safety information that shipped with your computer and follow the steps in [Before Working Inside Your Computer](#). After working inside your computer, follow the instructions in [After Working Inside Your Computer](#). For more safety best practices, see the Regulatory Compliance home page at dell.com/regulatory_compliance.

Procedure

- 1 Connect the control-buttons board cable to the control-buttons board.
- 2 Slide the control-buttons board into the slots on the display bezel and adhere it to the display bezel.

Postrequisites

- 1 Replace the [back cover](#).
- 2 Replace the [stand assembly](#).

Removing the Converter Board



WARNING: Before working inside your computer, read the safety information that shipped with your computer and follow the steps in [Before Working Inside Your Computer](#). After working inside your computer, follow the instructions in [After Working Inside Your Computer](#). For more safety best practices, see the Regulatory Compliance home page at dell.com/regulatory_compliance.

Prerequisites

- 1 Remove the [stand assembly](#).
- 2 Remove the [back cover](#).

Procedure

- 1 Disconnect the converter-board cables from the converter board.
- 2 Remove the screws that secure the converter board to the display-panel base.

3 Lift the converter board off the display-panel base.

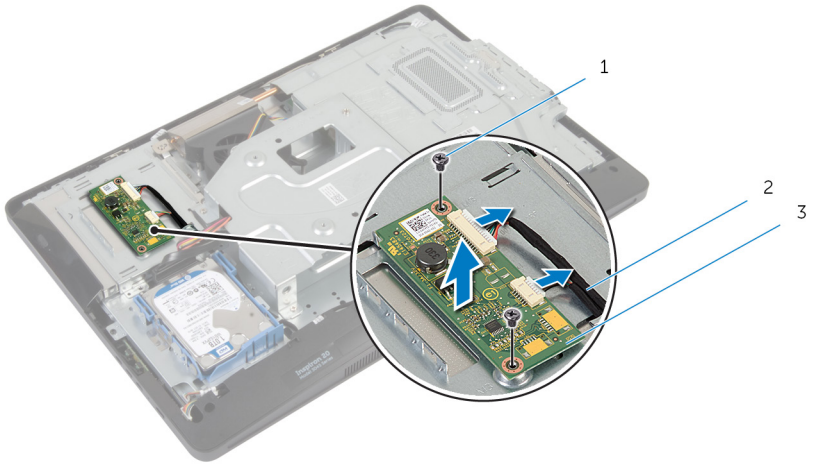

- 1 screws (2)
- 3 converter board

- 2 converter-board cables (2)

Replacing the Converter Board



WARNING: Before working inside your computer, read the safety information that shipped with your computer and follow the steps in [Before Working Inside Your Computer](#). After working inside your computer, follow the instructions in [After Working Inside Your Computer](#). For more safety best practices, see the Regulatory Compliance home page at dell.com/regulatory_compliance.

Procedure

- 1 Align the screw holes on the converter board with the screw holes on the display-panel base.
- 2 Replace the screws that secure the converter board to the display-panel base.
- 3 Connect the converter-board cables to the converter board.

Postrequisites

- 1 Replace the [back cover](#).
- 2 Replace the [stand assembly](#).

Removing the System-Board Shield

⚠ WARNING: Before working inside your computer, read the safety information that shipped with your computer and follow the steps in [Before Working Inside Your Computer](#). After working inside your computer, follow the instructions in [After Working Inside Your Computer](#). For more safety best practices, see the Regulatory Compliance home page at dell.com/regulatory_compliance.

Prerequisites

- 1 Remove the [stand assembly](#).
- 2 Remove the [back cover](#).

Procedure

- 1 Remove the screws that secure the system-board shield to the display-panel base.
- 2 Lift the system-board shield off the display-panel base.

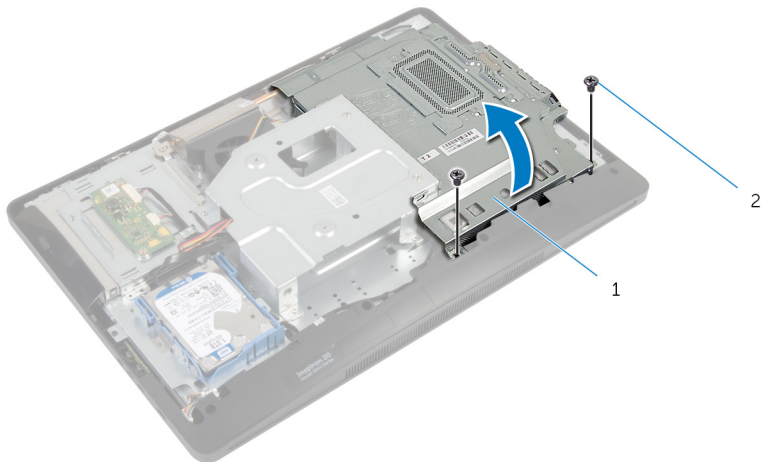

1 system-board shield

2 screws (2)

Replacing the System-Board Shield

 **WARNING:** Before working inside your computer, read the safety information that shipped with your computer and follow the steps in [Before Working Inside Your Computer](#). After working inside your computer, follow the instructions in [After Working Inside Your Computer](#). For more safety best practices, see the Regulatory Compliance home page at dell.com/regulatory_compliance.

Procedure

- 1 Slide the slots on the system-board shield into the ports on the system board.
- 2 Align the screw holes on the system-board shield with the screw holes on the display-panel base.
- 3 Replace the screws that secure the system-board shield to the display-panel base.

Postrequisites

- 1 Replace the [back cover](#).
- 2 Replace the [stand assembly](#).

Removing the Wireless Card



WARNING: Before working inside your computer, read the safety information that shipped with your computer and follow the steps in [Before Working Inside Your Computer](#). After working inside your computer, follow the instructions in [After Working Inside Your Computer](#). For more safety best practices, see the Regulatory Compliance home page at dell.com/regulatory_compliance.

Prerequisites

- 1 Remove the [stand assembly](#).
- 2 Remove the [back cover](#).
- 3 Remove the [system-board shield](#).

Procedure

- 1 Disconnect the antenna cables from the wireless card.
- 2 Remove the screw that secures the wireless card to the system board.

- 3 Slide and remove the wireless card from the wireless-card connector on the system board.

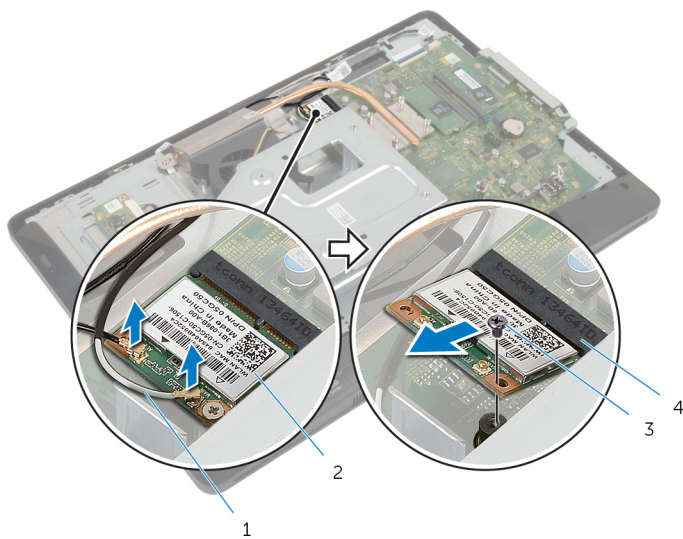

- 1 antenna cables (2)
3 screw

- 2 wireless card
4 wireless-card connector

Replacing the Wireless Card

 **WARNING:** Before working inside your computer, read the safety information that shipped with your computer and follow the steps in [Before Working Inside Your Computer](#). After working inside your computer, follow the instructions in [After Working Inside Your Computer](#). For more safety best practices, see the Regulatory Compliance home page at dell.com/regulatory_compliance.

Procedure

 **CAUTION:** To avoid damaging the wireless card, do not place any cables under it.

- 1 Align the notch on the wireless card with the tab on the wireless card connector.
- 2 Slide the wireless card at an angle into the wireless card connector on the system board.
- 3 Press the other end of the wireless card down and replace the screw that secures the wireless card to the system board.
- 4 Connect the antenna cables to the wireless card.



The following table provides the antenna-cable color scheme for the wireless card supported by your computer.

Connectors on the wireless card	Antenna-cable color
Main (white triangle)	White
Auxiliary (black triangle)	Black

Postrequisites

- 1 Replace the [system-board shield](#).
- 2 Replace the [back cover](#).
- 3 Replace the [stand assembly](#).

Removing the Coin-Cell Battery

-  **WARNING:** Before working inside your computer, read the safety information that shipped with your computer and follow the steps in [Before Working Inside Your Computer](#). After working inside your computer, follow the instructions in [After Working Inside Your Computer](#). For more safety best practices, see the Regulatory Compliance home page at dell.com/regulatory_compliance.
-  **CAUTION:** Removing the coin-cell battery resets the BIOS settings to default. It is recommended that you note the BIOS settings before removing the coin-cell battery.

Prerequisites

- 1 Remove the [stand assembly](#).
- 2 Remove the [back cover](#).
- 3 Remove the [system-board shield](#).

Procedure

- 1 Locate the battery socket on the [system board](#).
- 2 Push the securing clip away from the coin-cell battery until the coin-cell battery pops out.

3 Lift the coin-cell battery out of its socket.

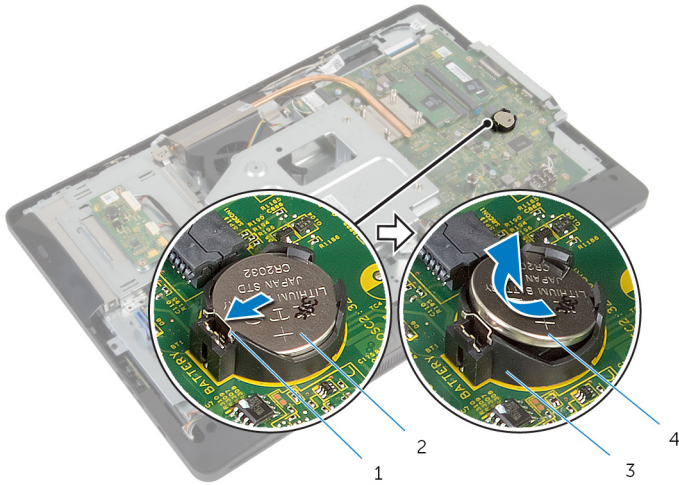

1 securing clip

3 coin-cell battery socket

2 coin-cell battery

4 positive side of the coin-cell battery

Replacing the Coin-Cell Battery

 **WARNING:** Before working inside your computer, read the safety information that shipped with your computer and follow the steps in [Before Working Inside Your Computer](#). After working inside your computer, follow the instructions in [After Working Inside Your Computer](#). For more safety best practices, see the Regulatory Compliance home page at dell.com/regulatory_compliance.



Procedure

With the positive side facing up, insert the new coin-cell battery (CR2032) into the battery socket and snap the battery into place.

Postrequisites

- 1 Replace the [system-board shield](#).
- 2 Replace the [back cover](#).
- 3 Replace the [stand assembly](#).

Removing the Heat Sink

-  **WARNING:** Before working inside your computer, read the safety information that shipped with your computer and follow the steps in [Before Working Inside Your Computer](#). After working inside your computer, follow the instructions in [After Working Inside Your Computer](#). For more safety best practices, see the Regulatory Compliance home page at dell.com/regulatory_compliance.
-  **WARNING:** The heat sink may become hot during normal operation. Allow sufficient time for the heat sink to cool before you touch it.
-  **CAUTION:** To ensure maximum cooling for the processor, do not touch the heat transfer areas on the heat sink. The oils in your skin can reduce the heat transfer capability of the thermal grease.

Prerequisites

- 1 Remove the [stand assembly](#).
- 2 Remove the [back cover](#).
- 3 Remove the [system-board shield](#).

Procedure

- 1 Remove the screw that secures the heat sink to the display-panel base.
- 2 In sequential order (indicated on the heat sink), loosen the captive screws that secure the heat sink to the system board.
 -  **NOTE:** The heat sink may look different on your computer depending on the configuration you ordered.

3 Lift the heat sink off the system board.

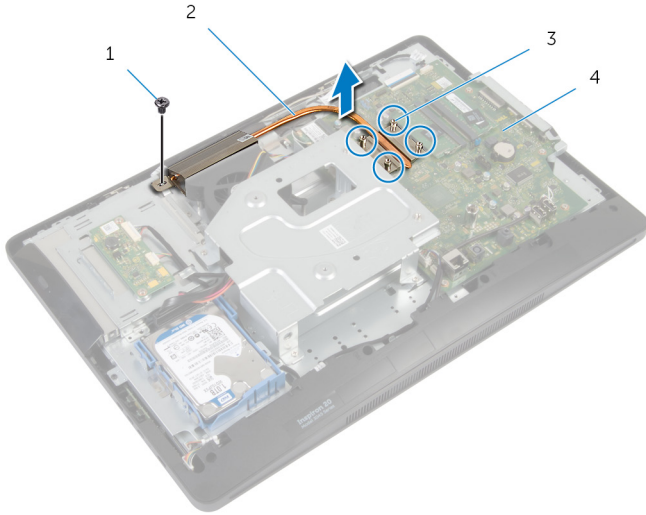



1 screw

3 captive screws (4)

2 heat sink

4 system board

Replacing the Heat Sink

-  **WARNING:** Before working inside your computer, read the safety information that shipped with your computer and follow the steps in [Before Working Inside Your Computer](#). After working inside your computer, follow the instructions in [After Working Inside Your Computer](#). For more safety best practices, see the Regulatory Compliance home page at dell.com/regulatory_compliance.
-  **CAUTION:** Incorrect alignment of the heat sink can cause damage to the system board and processor.

Procedure

 **NOTE:** The original thermal grease can be reused if the original processor and heat sink are reinstalled together. If either the processor or the heat sink is replaced, use the thermal grease provided in the kit to make sure that thermal conductivity is achieved.

- 1 Clean the thermal grease from the bottom of the heat sink and reapply the thermal grease.
- 2 Align the captive screws on the heat sink with the screw holes on the system board.
- 3 In sequential order (indicated on the heat sink), tighten the captive screws that secure the heat sink to the system board.
- 4 Replace the screw that secures the heat sink to the display-panel base.

Postrequisites

- 1 Replace the [system-board shield](#).
- 2 Replace the [back cover](#).
- 3 Replace the [stand assembly](#).

Removing the Speaker Cover

⚠ WARNING: Before working inside your computer, read the safety information that shipped with your computer and follow the steps in [Before Working Inside Your Computer](#). After working inside your computer, follow the instructions in [After Working Inside Your Computer](#). For more safety best practices, see the Regulatory Compliance home page at dell.com/regulatory_compliance.

Prerequisites

- 1 Remove the [stand assembly](#).
- 2 Remove the [back cover](#).
- 3 Remove the [system-board shield](#).

Procedure

- 1 Remove the screws that secure the speaker cover to the display bezel.
- 2 Lift the speaker cover off the display bezel.

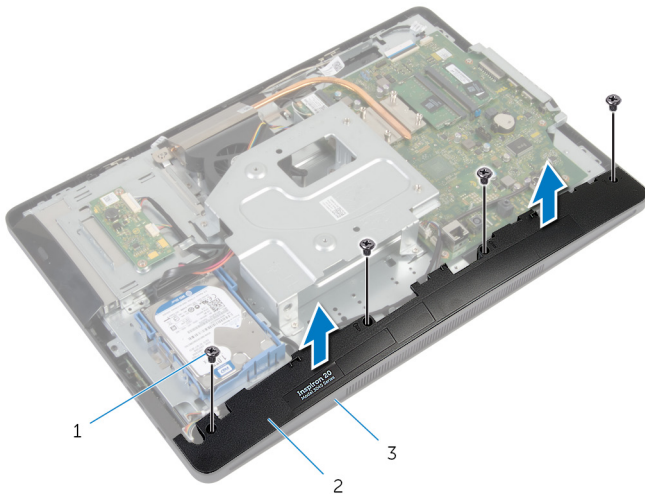

- 1 screws (4)
- 2 speaker cover
- 3 display bezel

Replacing the Speaker Cover



WARNING: Before working inside your computer, read the safety information that shipped with your computer and follow the steps in [Before Working Inside Your Computer](#). After working inside your computer, follow the instructions in [After Working Inside Your Computer](#). For more safety best practices, see the Regulatory Compliance home page at dell.com/regulatory_compliance.

Procedure

- 1 Align the screw holes on the speaker cover with the screw holes on the display bezel.
- 2 Replace the screws that secure the speaker cover to the display bezel.

Postrequisites

- 1 Replace the [system-board shield](#).
- 2 Replace the [back cover](#).
- 3 Replace the [stand assembly](#).

Removing the Speakers



WARNING: Before working inside your computer, read the safety information that shipped with your computer and follow the steps in [Before Working Inside Your Computer](#). After working inside your computer, follow the instructions in [After Working Inside Your Computer](#). For more safety best practices, see the Regulatory Compliance home page at dell.com/regulatory_compliance.

Prerequisites

- 1 Remove the [stand assembly](#).
- 2 Remove the [back cover](#).
- 3 Remove the [system-board shield](#).
- 4 Remove the [speaker cover](#).

Procedure

- 1 Disconnect the speaker cable from the system board.
- 2 Note the speaker cable routing and remove the cable from the routing guides on the display-panel base.
- 3 Remove the screws that secure the speakers to the display bezel.

4 Lift the speakers along with the cable off the display bezel.

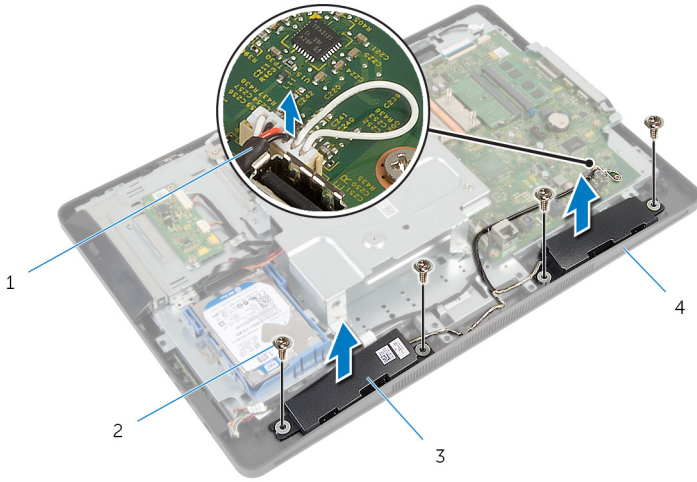

1 speaker cable
3 speakers (2)

2 screws (4)
4 display bezel

Replacing the Speakers



WARNING: Before working inside your computer, read the safety information that shipped with your computer and follow the steps in [Before Working Inside Your Computer](#). After working inside your computer, follow the instructions in [After Working Inside Your Computer](#). For more safety best practices, see the Regulatory Compliance home page at dell.com/regulatory_compliance.

Procedure

- 1 Align the screw holes on the speakers with the screw holes on the display bezel.
- 2 Replace the screws that secure the speakers to the display bezel.
- 3 Route the speaker cable through the routing guides on the display-panel base and then connect the speaker cable to the system board.

Postrequisites

- 1 Replace the [speaker cover](#).
- 2 Replace the [system-board shield](#).
- 3 Replace the [back cover](#).
- 4 Replace the [stand assembly](#).

Removing the Antenna(s)



WARNING: Before working inside your computer, read the safety information that shipped with your computer and follow the steps in [Before Working Inside Your Computer](#). After working inside your computer, follow the instructions in [After Working Inside Your Computer](#). For more safety best practices, see the Regulatory Compliance home page at dell.com/regulatory_compliance.

Prerequisites

- 1 Remove the [stand assembly](#).
- 2 Remove the [back cover](#).
- 3 Remove the [system-board shield](#).

Procedure

- 1 Note the location of the antennas and pry the antenna modules from the display bezel.
- 2 Note the antenna cables routing and disconnect the antenna cables from the wireless card.

3 Lift the antennas along with the cable off the display-panel base.

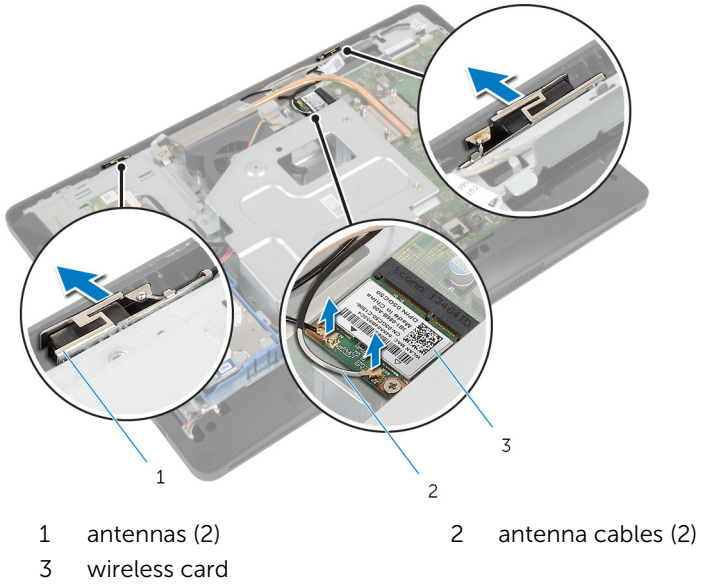

Replacing the Antenna(s)



WARNING: Before working inside your computer, read the safety information that shipped with your computer and follow the steps in [Before Working Inside Your Computer](#). After working inside your computer, follow the instructions in [After Working Inside Your Computer](#). For more safety best practices, see the Regulatory Compliance home page at dell.com/regulatory_compliance.

Procedure

- 1 Align and adhere the antennas to the display-panel base.
- 2 Route and connect the antenna cables to the wireless card.

Postrequisites

- 1 Replace the [system-board shield](#).
- 2 Replace the [back cover](#).
- 3 Replace the [stand assembly](#).

Removing the Fan



WARNING: Before working inside your computer, read the safety information that shipped with your computer and follow the steps in [Before Working Inside Your Computer](#). After working inside your computer, follow the instructions in [After Working Inside Your Computer](#). For more safety best practices, see the Regulatory Compliance home page at dell.com/regulatory_compliance.

Prerequisites

- 1 Remove the [stand assembly](#).
- 2 Remove the [back cover](#).
- 3 Remove the [system-board shield](#).
- 4 Remove the [VESA-mount bracket](#).

Procedure

- 1 Disconnect the fan cable from the system board.
- 2 Remove the screws that secure the fan to the display-panel base.

3 Lift the fan, along with its cable, off the display-panel base.

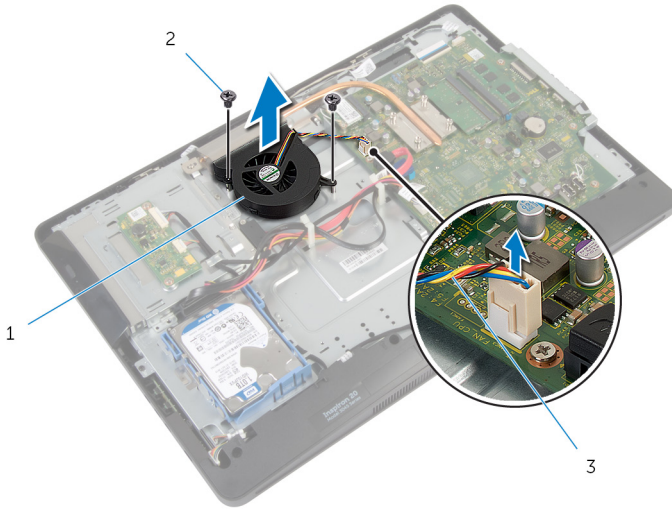

1 fan

3 fan cable

2 screws (2)

Replacing the Fan



WARNING: Before working inside your computer, read the safety information that shipped with your computer and follow the steps in [Before Working Inside Your Computer](#). After working inside your computer, follow the instructions in [After Working Inside Your Computer](#). For more safety best practices, see the Regulatory Compliance home page at dell.com/regulatory_compliance.

Procedure

- 1 Align the screw holes on the fan with the screw holes on the display-panel base.
- 2 Replace the screws that secure the fan to the display-panel base.
- 3 Connect the fan cable to the system board.

Postrequisites

- 1 Replace the [VESA-mount bracket](#).
- 2 Replace the [system-board shield](#).
- 3 Replace the [back cover](#).
- 4 Replace the [stand assembly](#).

Removing the System Board



WARNING: Before working inside your computer, read the safety information that shipped with your computer and follow the steps in [Before Working Inside Your Computer](#). After working inside your computer, follow the instructions in [After Working Inside Your Computer](#). For more safety best practices, see the Regulatory Compliance home page at dell.com/regulatory_compliance.



NOTE: Your computer's Service Tag is stored in the system board. You must enter the Service Tag in the system setup after you replace the system board.



NOTE: Before disconnecting the cables from the system board, note the location of the connectors so that you can reconnect them correctly after you replace the system board.

Prerequisites

- 1 Remove the [stand assembly](#).
- 2 Remove the [back cover](#).
- 3 Remove the [VESA-mount bracket](#).
- 4 Remove the [memory module\(s\)](#).
- 5 Remove the [system-board shield](#).
- 6 Remove the [wireless card](#).
- 7 Remove the [heat sink](#).

Procedure

- 1 Lift the latch and disconnect the display cable from the system board.
- 2 Disconnect the fan cable, optical-drive cable, hard-drive cable, hard-drive and optical-drive power cable, converter-board cable, control-buttons board cable, speaker cable, and camera cable from the system board.

For more information, see [System Board Components](#).

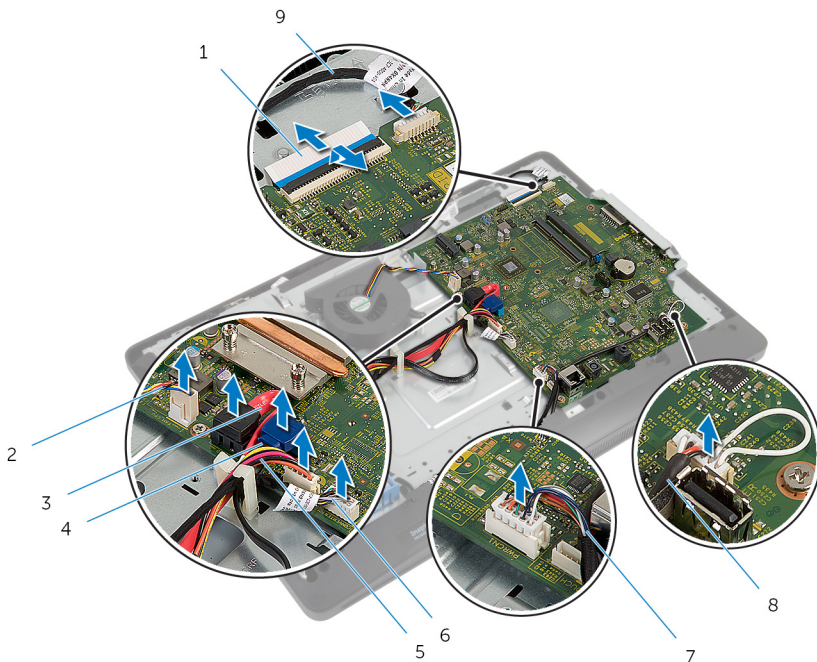

- | | |
|--|-------------------------|
| 1 display cable | 2 fan cable |
| 3 optical-drive cable | 4 hard-drive cable |
| 5 hard-drive and optical-drive power cable | 6 converter-board cable |
| 7 control-buttons board cable | 8 speaker cable |
| 9 camera cable | |

- 3 Remove the screws that secure the system board to the display-panel base.

- 4 Lift the system board at an angle and release the ports on the system board from the tab on the display-panel base.

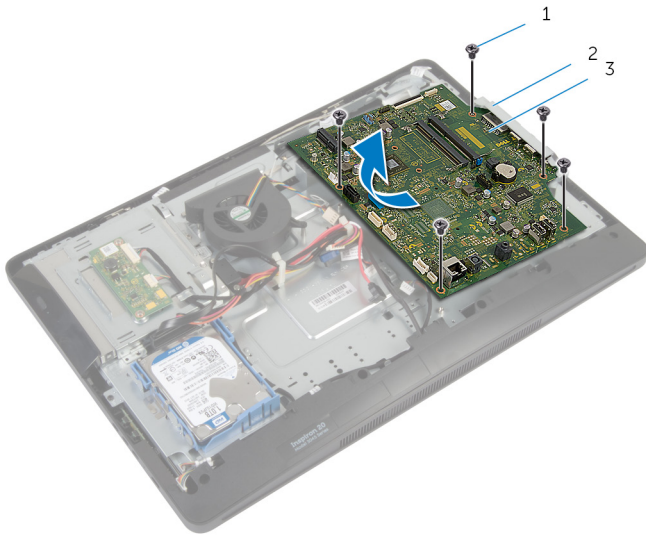

- 1 screws (5)
- 3 system board

- 2 tab

Replacing the System Board



WARNING: Before working inside your computer, read the safety information that shipped with your computer and follow the steps in [Before Working Inside Your Computer](#). After working inside your computer, follow the instructions in [After Working Inside Your Computer](#). For more safety best practices, see the Regulatory Compliance home page at dell.com/regulatory_compliance.



NOTE: Your computer's Service Tag is stored in the system board. You must enter the Service Tag in the system setup after you replace the system board.

Procedure

- 1 Slide the ports on the system board into the slots on the display-panel base and align the screw holes on the system board with the screw holes on the display-panel base.
- 2 Replace the screws that secure the system board to the display-panel base.
- 3 Connect the fan cable, optical-drive cable, hard-drive cable, hard-drive and optical-drive power cable, converter-board cable, control-buttons board cable, speaker cable, and camera cable to the system board.
For more information, see [System Board Components](#).
- 4 Slide the display cable in the connector on the system board and press down on the latch to secure the cable.

Postrequisites

- 1 Replace the [heat sink](#).
- 2 Replace the [wireless card](#).
- 3 Replace the [system-board shield](#).
- 4 Replace the [memory module\(s\)](#).
- 5 Replace the [VESA-mount bracket](#).
- 6 Replace the [back cover](#).
- 7 Replace the [stand assembly](#).

Removing the Camera



WARNING: Before working inside your computer, read the safety information that shipped with your computer and follow the steps in [Before Working Inside Your Computer](#). After working inside your computer, follow the instructions in [After Working Inside Your Computer](#). For more safety best practices, see the Regulatory Compliance home page at dell.com/regulatory_compliance.

Prerequisites

- 1 Remove the [stand assembly](#).
- 2 Remove the [back cover](#).
- 3 Remove the [system-board shield](#).

Procedure

- 1 Lift the connector latch and disconnect the display cable from the system board.
- 2 Disconnect the camera cable from the system board and remove the camera cable from the routing guides on the display-panel base.
- 3 Disconnect the speaker cable from the system board and remove the speaker cable from the routing guides on the display-panel base.
- 4 Disconnect the control-buttons board cable from the control-buttons board.

- 5** Disconnect the converter-board cable from the display-panel base.

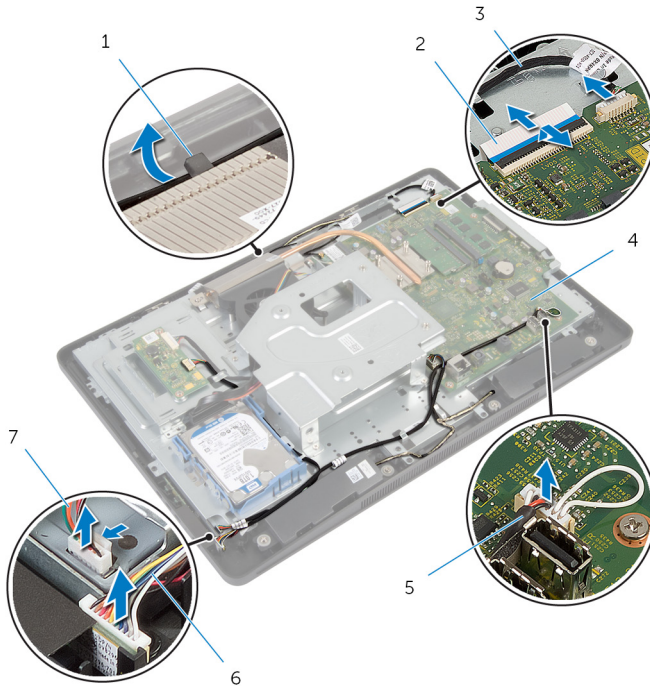

- | | | | |
|---|-----------------------|---|-----------------------------|
| 1 | routing guide | 2 | display cable |
| 3 | camera cable | 4 | system board |
| 5 | speaker cable | 6 | control-buttons board cable |
| 7 | converter-board cable | | |

- 6** Remove the screws that secure the display-panel base to the display bezel.
- 7** Push and release the tabs that secure the display-panel base to the display bezel.

8 Lift the display-panel base off the display panel.

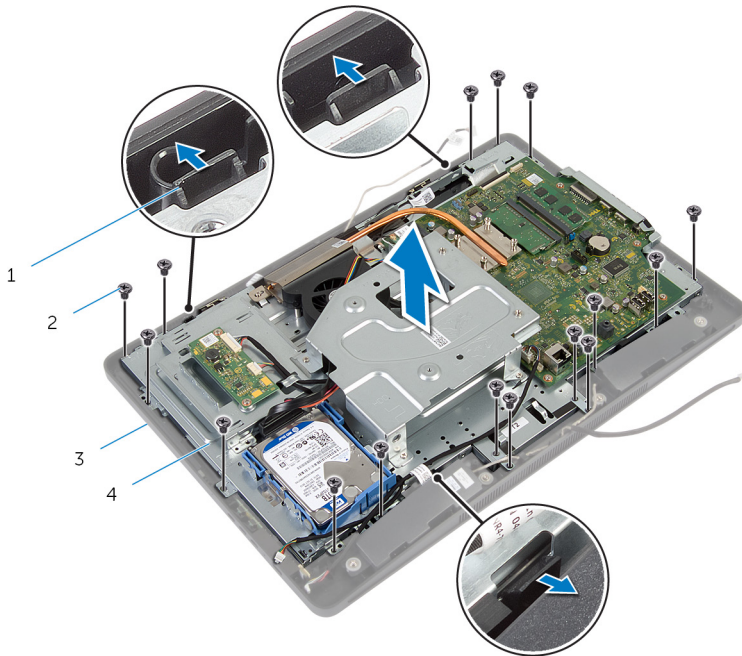

1 tabs (3)

2 screws (16)

3 display bezel

4 display-panel base

9 Remove the screws that secure the camera assembly to the display bezel.

10 Carefully lift the camera assembly and turn it over.

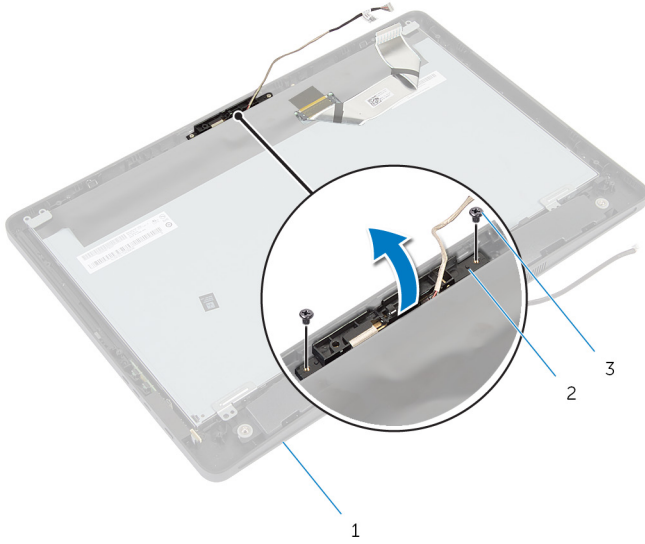

1 display bezel
3 screws (2)

2 camera assembly

11 Disconnect the camera cable from the camera assembly.

12 Remove the screw that secures the camera to the camera bracket.

13 Slide and remove the camera from the camera-module bracket.

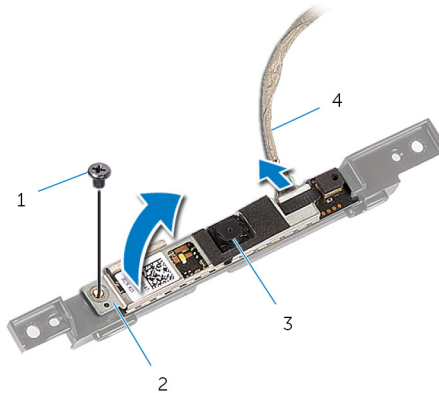

1 screw
3 camera

2 camera bracket
4 camera cable

Replacing the Camera



WARNING: Before working inside your computer, read the safety information that shipped with your computer and follow the steps in [Before Working Inside Your Computer](#). After working inside your computer, follow the instructions in [After Working Inside Your Computer](#). For more safety best practices, see the Regulatory Compliance home page at dell.com/regulatory_compliance.

Procedure

- 1 Slide the camera into the camera bracket and align the screw hole on the camera with the screw hole on the camera bracket.
- 2 Replace the screw that secures the camera to the camera bracket.
- 3 Connect the camera cable to the camera.
- 4 Align the screw holes on the camera assembly with the screw holes on the display bezel.
- 5 Replace the screws that secure the camera assembly to the display bezel.
- 6 Align the screw holes on the display-panel base with the screw holes on the display bezel and snap the display-panel base into place.
- 7 Replace the screws that secure the display-panel base to the display bezel.
- 8 Connect the converter-board cable to the connector on the display panel.
- 9 Connect the control-buttons board cable to the control-buttons board.
- 10 Route the speaker cable through the routing guides on the display-panel base and connect the speaker cable to the system board.
- 11 Route the camera cable through the routing guides on the display-panel base and connect the camera cable to the system board.
- 12 Slide the display cable into the connector on the system board and press down on the connector latch to secure the cable.

Postrequisites

- 1 Replace the [system-board shield](#).
- 2 Replace the [back cover](#).
- 3 Replace the [stand assembly](#).

Removing the Display Panel



WARNING: Before working inside your computer, read the safety information that shipped with your computer and follow the steps in [Before Working Inside Your Computer](#). After working inside your computer, follow the instructions in [After Working Inside Your Computer](#). For more safety best practices, see the Regulatory Compliance home page at dell.com/regulatory_compliance.

Prerequisites

- 1 Remove the [stand assembly](#).
- 2 Remove the [back cover](#).
- 3 Remove the [system-board shield](#).
- 4 Remove the [speaker cover](#).

Procedure

- 1 Lift the connector latch and disconnect the display cable from the system board.
- 2 Disconnect the camera cable from the system board and remove the camera cable from the routing guides.
- 3 Disconnect the speaker cable from the system board and remove the cable from the routing guides on the display-panel base.
- 4 Disconnect the control-buttons board cable from the control-buttons board.

- 5** Disconnect the converter-board cable from the display panel.

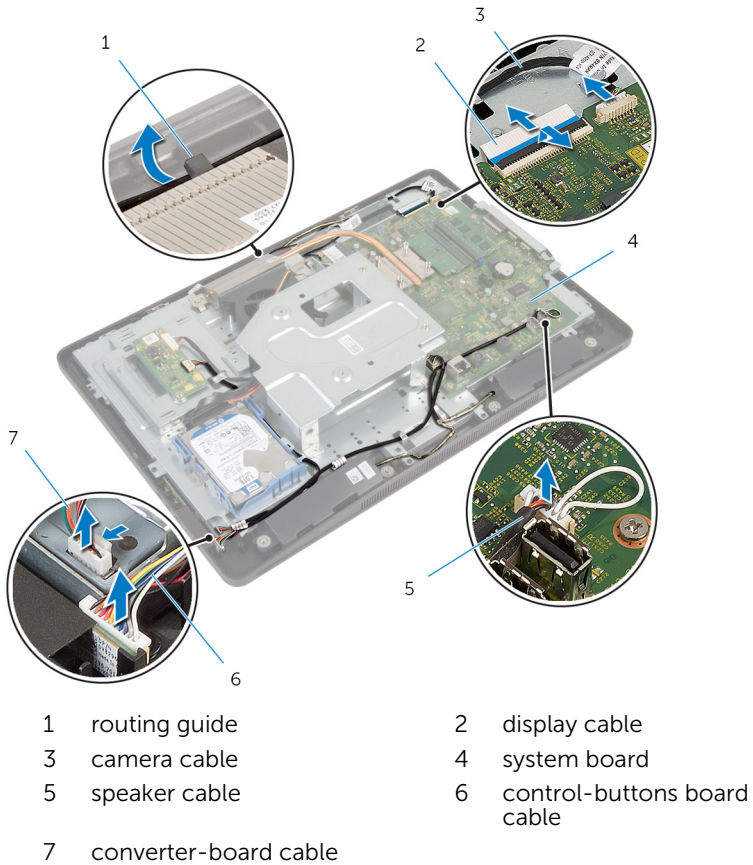

- 6** Remove the screws that secure the display-panel base to the display bezel.
- 7** Push and release the tabs that secure the display-panel base to the display bezel.

8 Lift the display-panel base off the display panel.

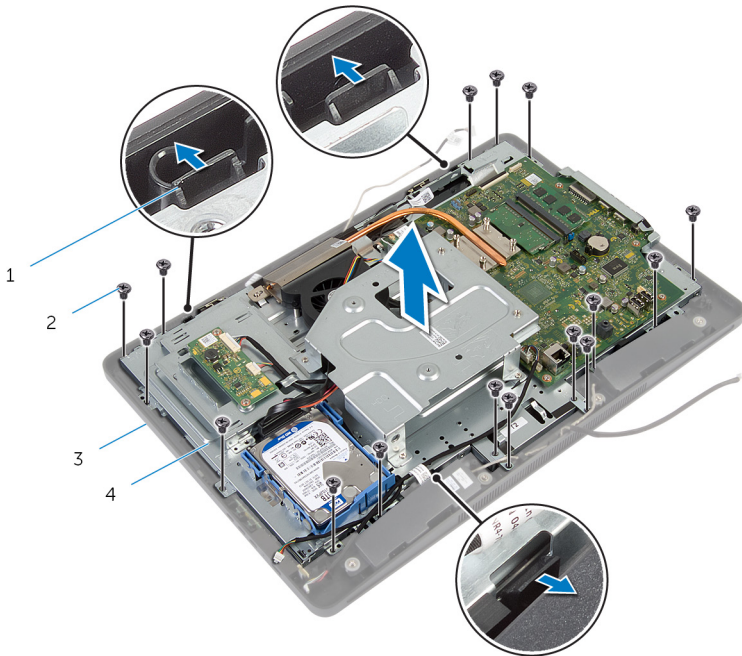

1 tabs (3)

2 screws (16)

3 display bezel

4 display-panel base

9 Peel the tape that secures the display cable to the connector on the display panel.

10 Press the release latch on either side of the display-cable connector and then pull the display cable to disconnect it from the display panel.

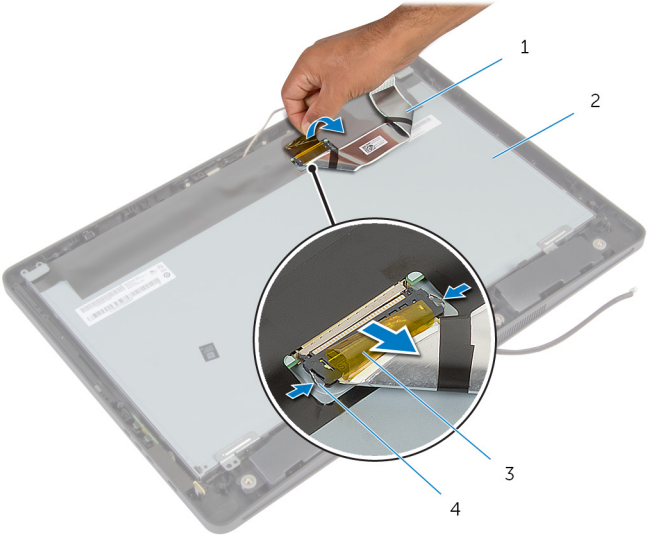

1 display cable
3 tape

2 display panel
4 release latches (2)

- 11** Lift the display assembly off the display bezel and place it on a clean surface.

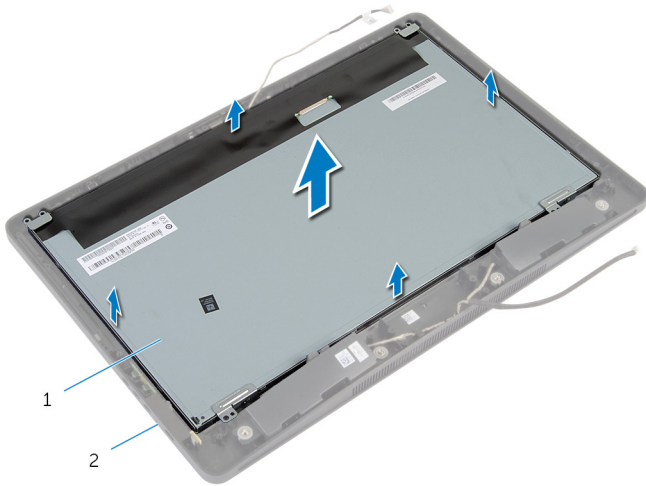

1 display panel

2 display bezel

- 12** Remove the screws that secure the display-panel brackets to the display panel.

13 Remove the display-panel brackets from the display panel.

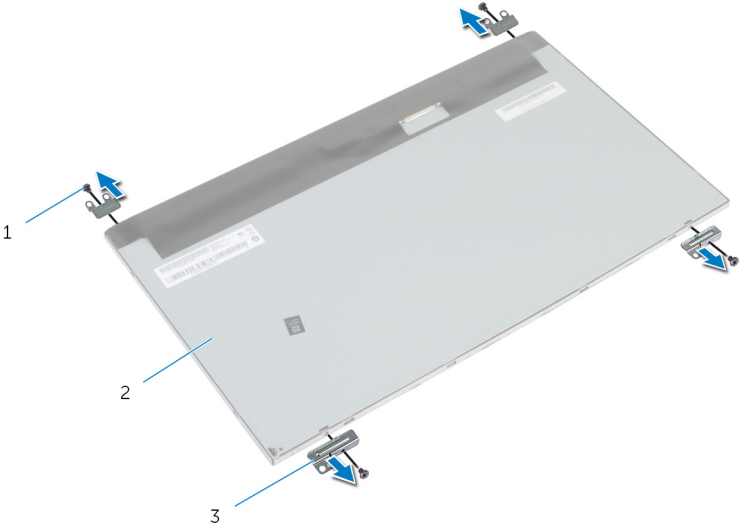

- 1 screws (4)
- 2 display panel
- 3 display-panel brackets (4)

Replacing the Display Panel



WARNING: Before working inside your computer, read the safety information that shipped with your computer and follow the steps in [Before Working Inside Your Computer](#). After working inside your computer, follow the instructions in [After Working Inside Your Computer](#). For more safety best practices, see the Regulatory Compliance home page at dell.com/regulatory_compliance.

Procedure

- 1 Align the screw holes on the display-panel brackets with the screw holes on the display panel.
- 2 Replace the screws that secure the display-panel brackets to the display panel.
- 3 Align the screw holes on the display panel with the screw holes on the display bezel and place the display panel on the display bezel.



NOTE: Make sure that no cables are under the display panel.

- 4 Connect the display cable to the connector on the display panel and secure the cable with the tape.
- 5 Align the screw holes on the display-panel base with the screw holes on the display bezel and snap the display-panel base into place.
- 6 Replace the screws that secure the display-panel base to the display bezel.
- 7 Connect the converter-board cable to the connector on the display panel.
- 8 Connect the control-buttons board cable to the control-buttons board.
- 9 Route the speaker cable through the routing guides on the display-panel base and connect the speaker cable to the system board.
- 10 Route the camera cable through the routing guides and connect the camera cable to the system board.
- 11 Slide the display cable into the system-board connector and press down on the connector latch to secure the cable.

Postrequisites

- 1 Replace the [speaker cover](#).
- 2 Replace the [system-board shield](#).

- 3 Replace the [back cover](#).
- 4 Replace the [stand assembly](#).

Flashing the BIOS

You may need to flash (update) the BIOS when an update is available or when you replace the system board. To flash the BIOS:

- 1 Turn on the computer.
- 2 Go to **dell.com/support**.
- 3 If you have your computer's Service Tag, type your computer's Service Tag and click **Submit**.

If you do not have your computer's Service Tag, click **Detect Service Tag** to allow automatic detection of the Service Tag.





NOTE: If the Service Tag cannot be detected automatically, select your product under the product categories.

- 4 Click **Get Drivers and Downloads**.
- 5 Click **View All Drivers**.
- 6 In the **Operating System** drop-down, select the operating system installed on your computer.
- 7 Click **BIOS**.
- 8 Click **Download File** to download the latest version of the BIOS for your computer.
- 9 On the next page, select **Single-file download** and click **Continue**.
- 10 Save the file and once the download is complete, navigate to the folder where you saved the BIOS update file.
- 11 Double-click the BIOS update file icon and follow the instructions on the screen.

Getting Help and Contacting Dell

Self-Help Resources

You can get information and help on Dell products and services using these online self-help resources:

Self-Help Information	Self-Help Options
Accessing Windows Help	Windows 8 — Open the Search charm, type Help and Support in the search box and press <Enter>. Windows 7 — Click Start  → Help and Support .
Information about Dell products and services	See dell.com
Troubleshooting information, user manuals, setup instructions, product specifications, technical help blogs, drivers, software updates, and so on	See dell.com/support
Information about Microsoft Windows 8	See dell.com/windows8
Information about Microsoft Windows 7	Click Start  → All Programs → Dell Help Documentation
Learn about your operating system, setting up and using your computer, data backup, diagnostics, and so on.	See <i>Me and My Dell</i> at dell.com/support/manuals .

Contacting Dell

To contact Dell for sales, technical support, or customer service issues, see **dell.com/contactdell**.

 **NOTE:** Availability varies by country and product, and some services may not be available in your country.



NOTE: If you do not have an active internet connection, you can find contact information on your purchase invoice, packing slip, bill, or Dell product catalog.